



DL-TBRG DATASHEET

TIPPING BUCKET RAIN GAUGE FOR LORAWAN®

FEATURES

LoRaWAN®-enabled tipping bucket rain gauge.

Meets the specifications of the World Meteorological Organization (WMO).

Resolution: 0.1 mm, catchment area: 200 cm².

Precipitation during the last sampling interval and total accumulated precipitation.

Extremely low power consumption.

Cable length: 1 m.

Compatible with LoRaWAN® networks of any provider.

Place and measure: no setup required.

Configurable via command line interface and downlink command interface.

Unattended real-time monitoring for several years without replacing batteries.

Robust polycarbonate enclosure: weatherproof, impact-, UV-resistant (IP67).

Standard alkaline (C-type) batteries.

CE compliant, Radio Equipment Directive (RED) 2014/53/EU.

APPLICATIONS

Outdoor remote monitoring.

Precipitation and weather monitoring.

Flood monitoring.

Smart agriculture.

DESCRIPTION

The tipping bucket rain gauge generates a pulse every time it senses 0.1 mm of water. Therefore, one pulse equals 0.1 mm rainfall. The device counts all these pulses. In regular intervals, usually after 10 minutes, the device reports three values: the number of pulses (precipitation) during the last interval, the duration of the interval in seconds and the total accumulated number of pulses (precipitation) since the last reset. The accumulated precipitation is very useful for reporting the amount of rain water over long periods. Moreover, the accumulated precipitation allows to calculate precipitation even for periods when no data could be transmitted to the network.

Sensor data are transmitted in real-time using LoRaWAN® radio technology. LoRaWAN® enables encrypted radio transmissions over long distances while consuming very little power. The user can obtain sensor data through Decentlab's data storage and visualization system, or through the user's own infrastructure. Visit www.decentlab.com for more information about Decentlab's data cloud service.

DEVICE VARIANTS

Name	Variant
DL-TBRG-001	001

DEVICE SPECIFICATIONS

DEVICE LOGGING FUNCTION

Sampling interval	10 min (configurable through the user interfaces)
Data upload interval	10 min (configurable through the user interfaces)
Reported sensor data (average of samples)	Precipitation Interval Accumulated precipitation (starting from last device reset) Battery voltage
SD-card logging	Optional

RAIN GAUGE

Operating principle	Tipping bucket rain gauge (unheated)
Resolution	0.1 mm per tip
Accuracy	2 % (0 ... 25 mm/h) 3 % (25 ... 50 mm/h)
Catchment area	200 cm ²

RADIO / WIRELESS

Wireless technology	LoRaWAN [®]
Wireless security	AES-128 data encryption
LoRaWAN [®] device type	Class A end-device
Supported LoRaWAN [®] features	OTAA, ABP, ADR, adaptive channel setup
Wireless range	> 10 km (line of sight ¹), approx. 2 km (suburban)
RF transmit power	14 dBm (25 mW)
Effective radiated power	11.9 dBm maximum ²
Receiver sensitivity	-146 dBm ³
Frequency bands	868 MHz (EU version), 915 MHz (US, AS, AU versions) ⁴
Antenna	Integrated omnidirectional antenna featuring a near-perfect radiation pattern ²

1 Decentlab reports successful transmissions over 56 km distance and more

2 See Appendix A: Antenna performance

3 Specified by radio chip vendor

4 Contact us for region specific options

POWER SUPPLY

Internal battery type	2 × alkaline C batteries (LR14)
Power consumption (average)	≤ 0.5 mW (10 min interval)
Battery lifetime estimation ⁵	12.1 years (10 min interval, SF7) 4.5 years (10 min interval, SF12) 16.9 years (60 min interval, SF7) 12.2 years (60 min interval, SF12)

OPERATING CONDITIONS

Temperature	-20 ... 50 °C
Humidity	0 ... 100 % RH

MECHANICAL SPECIFICATIONS

Rain gauge dimensions	Diameter: 180 mm, height 300 mm (390 mm with mounting base)
Rain gauge mounting	Clamp for iron pipe (34 mm diameter) or 3 bolts on 160 mm diameter circle
Rain gauge weight	1130 g including cable
Cable length	1 m
Sensor device dimensions	135 × 81 × 70 mm (not including sensor / cable)
Sensor device weight	400 g including batteries (270 g without batteries)
Sensor device material, IP rating	Polycarbonate; weatherproof, impact-, UV-resistant (IP66/IP67). Pressure equalizer plug with PTFE membrane (IP68).

⁵ Including alkaline battery self-discharge of 3.6 % per year (conservative estimation); battery capacity: 20000 mWh.

OPERATING INSTRUCTIONS

The product usually requires no user interaction. If you open the enclosure, e.g. in order to replace the batteries, unscrew the four plastic screws and carefully open the lid.

CAUTION: Make sure the sensor unit does not drop out of the enclosure while opening! Do not touch the electronic components and sensors!

NOTE: When closing the lid, make sure the lid is fitted the right way, so that the enclosure is properly sealed: A little nose in the enclosure fits a notch in the lid and vice versa.

REPLACING BATTERIES

Insert 2 high-quality alkaline C batteries (LR14) into the battery holder on the back side of the sensor unit. The device operates until the battery voltage drops to 2.0 V. Always replace both battery cells with two identical fresh batteries.

USER BUTTON AND LEDs

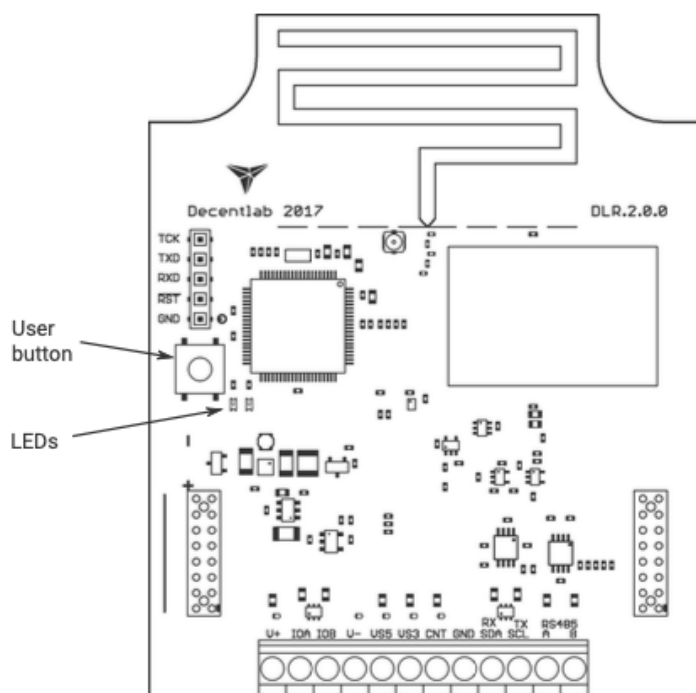

Illustration 1: Sensor unit showing the user button and LEDs. The battery holder is on the back side of the sensor unit.

OPERATING MODES

The device has four operating modes:

- **Reset:** System (re-)start; both LEDs fade in and out.
- **Active mode (ON):** Periodic measurements and data transmissions; green LED flashes for each measurement.
- **Sleep mode (OFF):** No measurements and data transmissions (power save mode, for shelf storage). LEDs are off.
- **Test mode:** Measurements and data transmissions at fastest possible rates; blue LED is on.
NOTE: Use only momentarily, e.g. for testing the sensor or the wireless connection. The device will switch automatically to active mode after 20 minutes.

SWITCHING BETWEEN OPERATING MODES

The user button allows to switch between the operating modes as shown in Illustration 2 and Illustration 3. To perform a device reset, switch to sleep mode first (if necessary) by pushing and holding the button for 3 seconds until the LEDs flash three times; wait 3 seconds; then push and hold the button for 3 seconds until the LEDs fade in and out. To switch between active and test mode, push the button for 1 second (blue LED on / off). If the blue LED is off, the device is in active or sleep mode. If the blue LED is on, the device is in test mode.

HINT: To check whether the device is active or in sleep mode (on or off), push the button twice; if the blue LED goes on and off, the device is in active mode; otherwise, the device is in sleep mode.

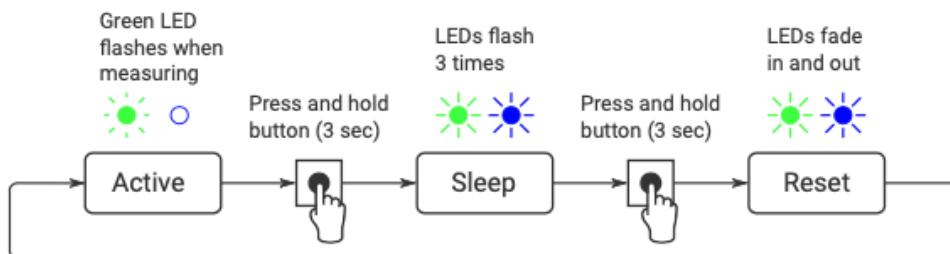

Illustration 2: Switching between active and sleep mode (switch off / on, reset).

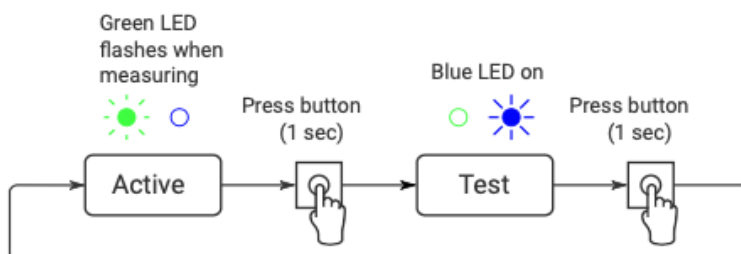

Illustration 3: Switching between active and test mode.

MEASUREMENT CYCLE (ACTIVE MODE)

During the active mode, the device periodically reads the sensors with sampling period $T_s = 10$ minutes (default, configurable). When the send period $T_{TX} = n \cdot T_s$ (default: $n = 1$, configurable) has expired, the device computes the average of the collected sensor values (at most 20 values). After a random delay of 0 ... 8 seconds, the device transmits the aggregated sensor data. If the device has not yet joined the LoRaWAN® network, it will try to join until it succeeds (maximum 3 attempts per sampling period). Afterwards, it will transmit the data (TX data). Following the data transmission, two receive slots are opened (RX1 and RX2). During these time slots, the device is ready to receive data from the network (downlink messages) as defined in the LoRaWAN® specification.

As shown in the diagrams, the device is idle most of the time. During the idle time, the current consumption is extremely low.

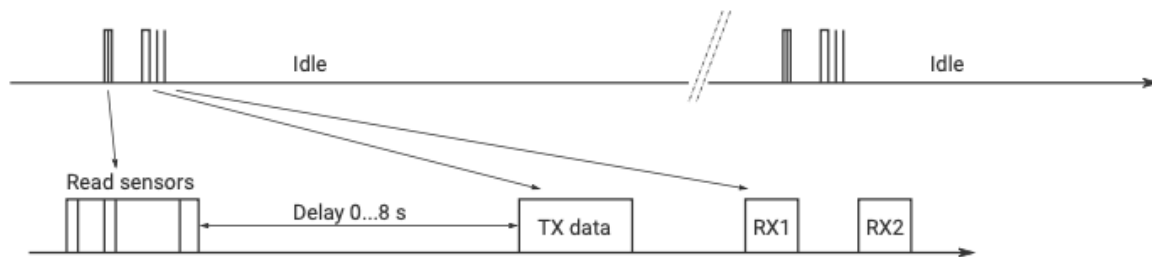

Illustration 4: Device activity during the active mode.

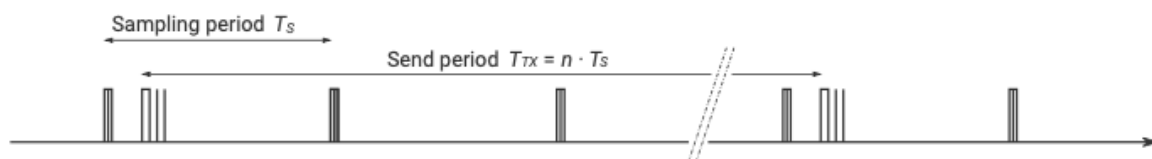

Illustration 5: Sampling period vs. send period. Default: $T_s = 10$ min, $T_{TX} = 1 \cdot 10$ min = 10 min.

LED SIGNALING (ACTIVE MODE)

- Read sensors: green LED flashes once.
- Data sent successfully: green LED flashes 2 times.
- Data could not be sent: green LED flashes 4 times.

DEVICE CONFIGURATION

The user can configure a rich set of device parameters, such as sampling interval, LoRaWAN® data rate, ADR settings and many more. If desired, the parameter settings can be stored permanently in the internal non-volatile memory. The user can configure the device via two interfaces:

- Command line interface: via a serial cable (UART – USB) connected to a computer.
- Downlink command interface: over the air using LoRaWAN® downlink messages.

For a full description of the command line interface and the downlink command interface, please find the specific documents on www.decentlab.com/support.

MOUNTING INSTRUCTIONS

For best radio performance, install the device upright with the cable towards ground; ideally, in such a way that the device lid faces roughly in the direction of the next gateway. Also, the higher above ground, the better. Avoid metallic objects close to the device.

The housing includes 4 threaded bushes (M4) in a 90 × 60 mm rectangle (see Illustration 6). This enables easy installation using standard M4 bolts.

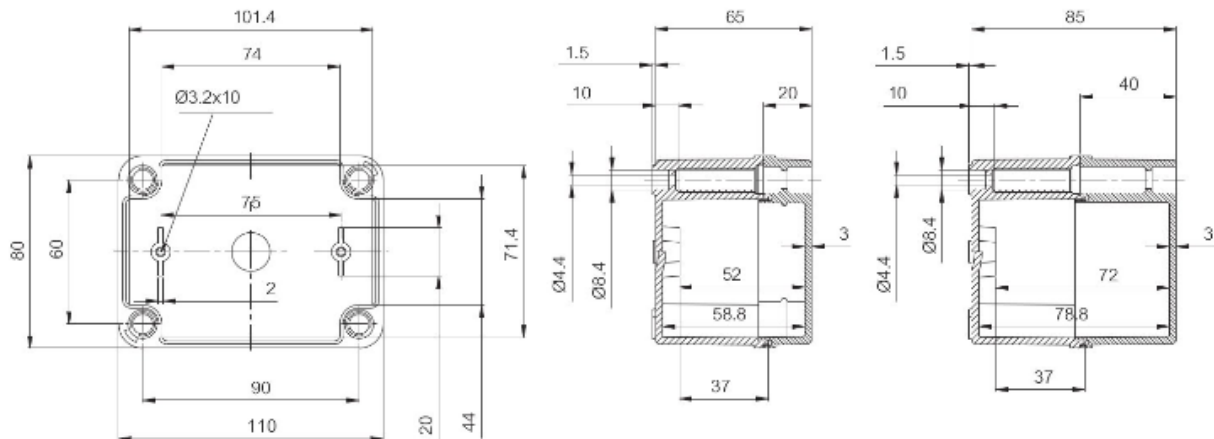

Illustration 6: Housing dimensions (in mm). Note: Drawing not including cable gland and sensor.

ORDERING INFORMATION

REFERENCE	VERSION	REGION (LORAWAN)
DL-TBRG-001-EU868	001	Europe
DL-TBRG-001-US915	001	North America
DL-TBRG-001-AS923	001	Asia
DL-TBRG-001-AU915	001	Australia, South America

Other options: contact us

SENSOR DATA MESSAGE FORMAT

Message:

Header	Sensor 0 data (optional)	Sensor 1 data (opt.)	...	Sensor 15 data (opt.)
--------	--------------------------	----------------------	-----	-----------------------

- Message length is variable, depending on which sensor data are included. Minimum length is 5 bytes (header only). Maximum length is 5 bytes + all sensor data (see below).
- Integers are big endian: MSB first byte, LSB last byte.

Header:

Version	Device ID	Flags
---------	-----------	-------

- Version: 1 byte; version = 2 for current protocol version.
- Device ID: 2 bytes; 0...65535.
- Flags: 16 bits: flag 15 | flag 14 | ... | flag 0 (LSB).
- The flags indicate, if data of the respective sensors are included in the message or not: Flag n == 1: sensor n data included; flag n == 0: not included.

DECODER SOFTWARE

For message decoder software, please go to <https://www.decentlab.com/support>, where you find code examples in JavaScript and other programming languages.

DETAILS

FIELD	PARAMETER NAME	TYPE	CONVERSION	UNIT
Header	Version	uint8		
Header	Device ID	uint16		
Header	Flags	uint16		
Sensor 0	Precipitation in interval	uint16	x · resolution	mm
Sensor 0	Interval	uint16	x	s
Sensor 0	Accumulated precipitation (A_{LSB})	uint16	x · resolution	mm
Sensor 0	Accumulated precipitation (A_{MSB})	uint16	x · resolution	mm
Sensor 1	Battery voltage	uint16	x / 1000	V

Resolution is the amount of precipitation causing a single tipping event, e.g. resolution = 0.1 mm.

The **total accumulated precipitation** (starting from device reset) is

$$T = A_{LSB} + A_{MSB} \cdot 65536 \text{ [mm]}.$$

EXAMPLE 1 (ALL SENSOR DATA INCLUDED)

Message (hex):

0202f8000300040258409a00000c54		(resolution = 0.1 mm)	
02	Version	= 2	
02f8	Device ID	= 760	
0003	Flags	= 0b0000000000000001	
0004	Precipitation in interval	= 0.4	mm
0258	Interval	= 600	s
409a	Accumulated precipitation (A_{LSB})	= 1653.8	mm
0000	Accumulated precipitation (A_{MSB})	= 0	mm
0c54	Battery voltage	= 3.156	V
	Total accumulated precipitation	= 1653.8	mm

EXAMPLE 2 (ONLY BATTERY VOLTAGE)

Message (hex):

0202f800020c54			
02	Version	= 2	
02f8	Device ID	= 760	
0002	Flags	= 0b0000000000000010	
----	Precipitation in interval	= ---	mm
----	Interval	= ---	s
----	Accumulated precipitation (A_{LSB})	= ---	mm
----	Accumulated precipitation (A_{MSB})	= ---	mm
0c54	Battery voltage	= 3.156	V
	Total accumulated precipitation	= ---	mm

DECLARATION OF CONFORMITY

We,

Decentlab GmbH
 Kriesbachstrasse 30
 8600 Dübendorf
 Switzerland



declare under our own responsibility that the product

Reference	Name
DL-TBRG-xxx-EU868	Tipping Bucket Rain Gauge for LoRaWAN®

to which this declaration refers conforms with the relevant standards or other standards documents

- EN 300 220-1 V3.1.1: 2017-02
- EN 300 220-2 V3.1.1: 2017-02
- EN 301 489-1 V2.2.0: 2017-03
- EN 301 489-3 V2.1.1: 2017-03

According to

- Radio Equipment Directive (RED) 2014/53/EU
- Electromagnetic Compatibility (EMC) Directive 2014/30/EU

Dübendorf, 12. September 2018

Reinhard Bischoff, Managing Director



APPENDIX A: ANTENNA PERFORMANCE

No : DE.17.039.F01

Page 21 / 24

Measurement Results:

EUT	DLR1-LP8		
Test performed	Effective radiated power (ERP)		
Verdict, Test	Pass		
Modification	None		
Mode of operation	Transmitter mode		
Test date, time	13.06.2018 09:37:06		
Antenna height	1.30 m	Antenna polarization	Vertical
EUT position	0 to 360 Degree	Antenna distance	3 m
Measurement settings	Radimantion Version: 2017.1.6, RBW: 1 kHz, VBW: 300 kHz, Sweep time: Auto [120 ms], Step freq: Linear: 250 Hz steps, Attenuator: Auto [10 dB], Internal preamp: 20 dB, Measure time: 10 ms, Measurement equipment: TP_RE_30M-1G_ETSI_Ver		

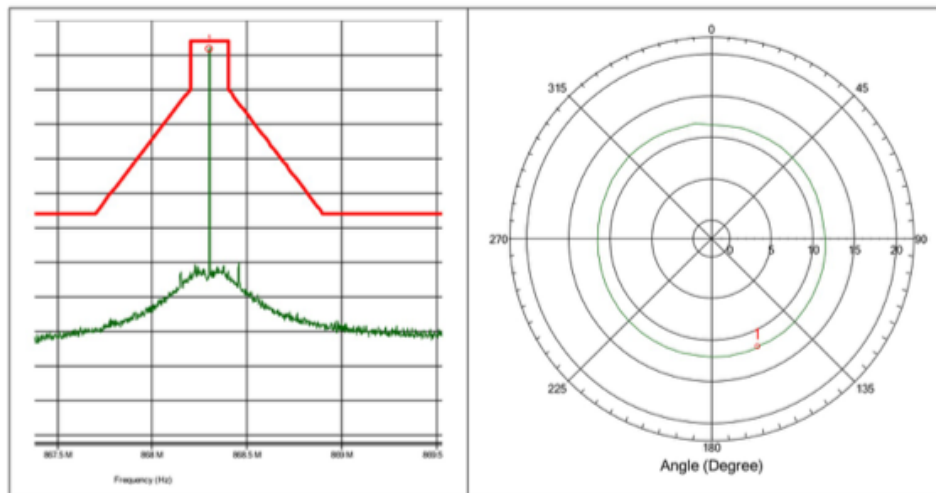

Detected peaks

Peak Number	Frequency	Peak	Peak Difference	Status	Angle	Height	Polarization
1	868.302 MHz	11.9 dBm	-2.14 dB	Pass	157 Degree	1.3 m	Vertical

Limits:

ETSI EN 300 220-2, Table C.1 OFB: 863 MHz to 870 MHz <= 0.1% duty cycle or polite spectrum access	25 mW e.r.p (14 dBm)
---	------------------------------------

DISCLAIMER

Specifications and information in this document are subject to change without notice.

Decentlab products are not warranted or authorized for use as critical components in medical, life-saving, or life-sustaining applications, or other applications where a failure would reasonably be expected to cause severe personal injury or death.

CONTACT INFORMATION

www.decentlab.com/contact

mail@decentlab.com

+41 44 809 35 90

Decentlab GmbH
Kriesbachstrasse 30
8600 Dübendorf
Switzerland