

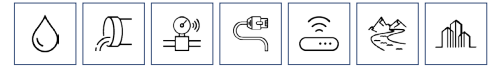

Water



Wastewater



Q-Eye PSC

For partially filled or pressurized pipes and open channels

Stationary area velocity flowmeter



Your benefits

- Stable water level measurement even when the sensor is tilted (up to 10°):
Guarantees successful installation without loss of accuracy
- Integrated temperature sensor:
Highly reliable flow and level data. Enhanced information, e.g. for infiltration studies
- Passive sensor, no electronics inside:
Maximum sensor robustness and lifetime, minimized total cost of ownership
- Platform-independent web interface:
Easy and fast setup. Parametrization with any mobile device, no software needed
- Integrated Wi-Fi access point and LAN interface, optional mobile connection:
Efficient system integration, real-time remote access anytime and anywhere

Applications

- Full or partially full pipes and open channels with flow depths of 40-1500 mm
- Ideal for sites with non-uniform or rapidly changing flow behavior. Suitable for applications with low and high water levels
- Continuous flow monitoring in slightly to heavily polluted media:
 - Wastewater treatment plants
 - Wastewater collection systems
 - Stormwater management
 - Industry

Properties

- Compact aluminum housing, IP66 (NEMA 4)
- Low-profile area velocity sensor, stainless steel, IP68
- Insertion sensor that does not protrude into the flow, IP68
- Scanning of the entire velocity profile in up to 32 measuring cells
- Integrated temperature measurement and compensation
- Angle compensation for area velocity sensor, up to 10° tilt
- Measurement of low velocities down to 0.04 m/s
- Bi-directional measurement over the entire flow range
- Typical uncertainty: $\pm 2\%$ of reading for flow (in ideal condition)
- Integrated Wi-Fi access point
- Preconfigured cross sections or user-definable irregular shapes
- Analog inputs for external sensors (2-wire loop-powered)
- Multiple analog and digital outputs, user programmable
- Communication: Ethernet, Modbus RTU/TCP, optional 4G/3G/2G modem
- Power supply: 100-240 V AC or 9-36 V DC
- ATEX for area velocity sensor available

Options

- Area velocity sensor to be mounted on pipe or channel bottom (up-looking) or wall (side-looking)
- Multiple velocity sensors in one cross section (up to 3)
- Insertion sensor for pipes that are only accessible from the outside
- Additional external level sensors (pressure, non-contact ultrasonic or radar)



WELKO Av. Providencia 2330, Of. 63
 +56 9 3174 3870 / +56 9 3427 0017
ventas@welko.cl - www.welko.cl

Product description

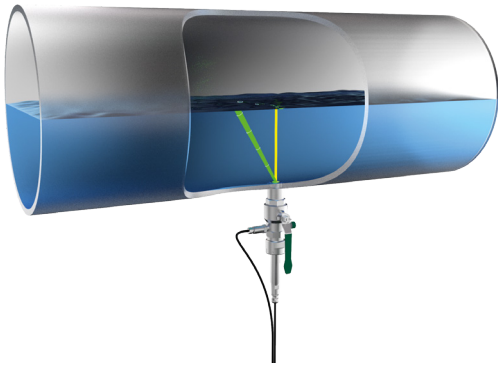

Insertion sensor with pressure transducer

WebUI

The Q-Eye PSC is equipped with an integrated web server running a WebUI. You can display and manage the WebUI using the standard web browser of your smartphone, tablet, PC or notebook. There is no need for any additional software or App. Parameter setting and data visualization has never been so easy.



Data transmission

Combine the Q-Eye PSC with an integrated 4G cellular modem for automatic data transmission. The logged data can be sent to any host computer (FTP server) or to the myGWF cloud solution at a user-selectable interval. Alternatively, wireless LAN and Ethernet connections are available.

Information on user-definable measurement parameters can be transmitted and stored at regular intervals between 30 seconds and 60 minutes. The Q-Eye PSC is equipped with internal storage capacity and will store data for up to 12 months.

The Q-Eye PSC area velocity flowmeter is designed for stationary flow monitoring of slightly to heavily polluted media in full or partially full pipes or open channels.

It uses advanced Pulse-Coherent cross-correlation technology to directly evaluate velocity profiles, making it the best choice for sites with non-uniform or rapidly changing flow conditions. The profiling capacity, in combination with the integrated temperature compensation, eliminates the need for periodic on-site calibration. This significantly reduces the total cost of ownership. Additionally, the Q-Eye PSC measures bi-directional flow over the entire measurement range and near zero flow velocities down to 0.04 m/s.

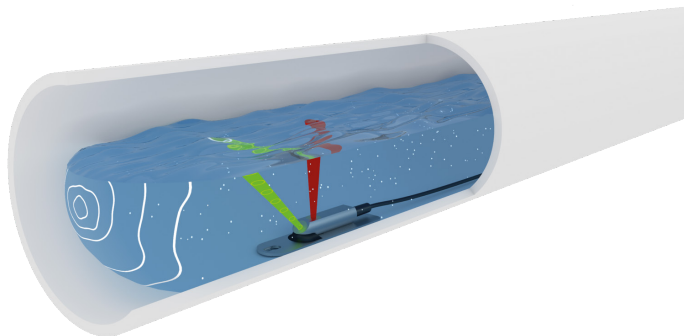

Q-Eye PSC area velocity sensor

Measuring principle

The Q-Eye PSC is a major improvement in open channel flow measurement. It is the state-of-the-art wastewater system in the GWF family of high-accuracy metering products. In contrast to older Continuous Wave Doppler systems, the Q-Eye PSC transmits acoustic pulses into the flow. These sound pulses are reflected by the particles in the medium. The resulting reflection patterns are analyzed for different regions (cells) of the flow profile. By tracking the movement of the particles in each measurement cell, the entire flow velocity profile can be scanned.

The best-in-class Pulse-Coherent cross-correlation technology allows for measurements in up to 32 cells with a cell size of only a few millimeters. Thus the velocity profile can be measured with a much higher resolution than with other common flowmeters. The measurement update interval of 1 Hz allows detailed tracking of changes in the flow profile and highly accurate mean velocity calculation.

By means of the PSC technology, it is possible to measure flow velocity very close to the sensor as well as in greater distances. This makes the Q-Eye PSC suitable for both shallow and deep water level applications.

Component description

The Q-Eye PSC system can be composed of a wall-mounted transmitter and several sensor options. The submersible area velocity sensor offers combined velocity and water level measurement for direct flow calculation with only one sensor. The insertion velocity sensor can be used as a stand-alone solution for pressurized pipes or combined with a pressure transducer for partially filled pipes.

Transmitter



Wall-mounted transmitter

The Q-Eye PSC transmitter incorporates all the required algorithms and software to ensure measurement accuracy and repeatability. The IP66 (NEMA 4X) compact housing features a 4 x 20 alphanumeric LCD display and a 4-button keypad.

All configuration data as well as measured and calculated data are stored inside a 16 GB Micro-SD card. The transmitter controls the measurements, calculates the flow rate and provides freely programmable current outputs, status alarms, frequency outputs and totalizer readings.

Sensors



Insertion velocity sensor and Low-profile area velocity sensor

The submersible area velocity sensor measures only 19 x 24 x 129 mm. Its low profile causes no interference in the flow, which results in more accurate velocity measurements, especially in low-flow situations. The integrated temperature sensor allows for automatic compensation of level and velocity data. A sensor tilt of up to 10° from the vertical axis to the water surface is compensated by the system, resulting in a higher installation flexibility.

The insertion sensor is for use in full pipes or partially filled pipes in combination with an integrated pressure transducer. It is mounted flush with the inner pipe wall, allowing pipes to be cleaned without dismantling the sensor. Thanks to the integrated ball valve, the sensor can be removed under process conditions, for example during maintenance works.

Mounting systems



Mounting plate, spring ring and scissors rings

Standardized accessories include mounting plates, spring rings, and scissors rings. Thus, the sensors can be installed within minutes, reducing time in the manhole. The sensor is first attached to a carrier and can then be fixed onto any of the compatible mounting systems. To install the sensors in rectangular, trapezoidal or earthen channels, we recommend the sensor mounting plate. Stainless steel spring rings simplify sensor installation in cylindrical pipes. 8 standard diameters from 100 mm to 600 mm are available.

You can install the sensor and fix the cable to a mounting ring before entering the manhole. In this way, the time spent in the sewer is significantly reduced. The rings can be expanded with a screw mechanism against the wall of the sewer. The expanding pressure makes undesired shifting of the ring impossible.

The adjustable scissors ring is installed in large pipes from 500 mm to 1450 mm in diameter. It consists of a base element with a scissors mechanism and one or more pairs of extensions to fit the size of the pipe.

Technical Data

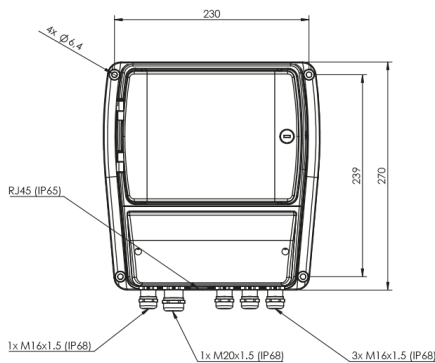

Transmitter	Q-Eye PSC
Display	4 lines, 20 characters
Keyboard	4 keys
Datalogger	16 GB Micro SD card
Communication	RS-485, Modbus (RS-232 or RS-485), Wireless LAN, 4G (LTE) / 3G (HSPA+) / 2G, Ethernet 10/100 Mbps
Inputs	max. 4 x 4-20 mA, 2 x digital
Outputs	max. 4 x 4-20 mA, 4 x relay, 2 x digital
Power supply	9-36 V DC or 100-240 V AC (50/60 Hz)
Approval	IP66 (NEMA 4)
Enclosure	Aluminium
Operating temperature	-20 °C to +60 °C
Storage temperature	-20 °C to +70 °C
Dimensions	270 x 256 x 139 mm (L x W x H)

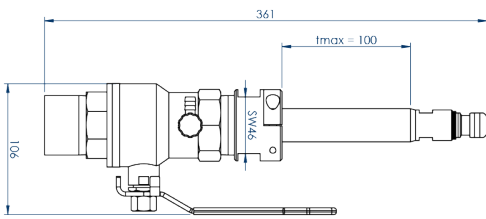

Sensor	Insertion sensor
Sensor	Velocity sensor for closed pipes incl. ball valve Optional with integrated pressure transducer
Frequency	1 MHz
Range	Velocity: +/- 5.0 m/s Level (pressure transducer): 0 to 0.2 bar or 0 to 10 bar
Uncertainty velocity	Velocity: ± 0.03 m/s from -1.5 m/s to +1.5 m/s ± 2 % of reading from -5.0 to -1.5 m/s and +1.5 to +5.0 m/s Temperature: ± 0.5 K for 4 °C to 57 °C
Error band pressure transducer (0 to 50 °C)	Max. 1.5 % FS (0.2 bar) or 0.5 % FS (10 bar)
Cable length	10 m incl. (max. 80 m)
Material	Stainless steel 1.4301 (AISI 304)
Dimensions	Diameter: 38 mm (1.5")

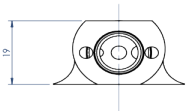
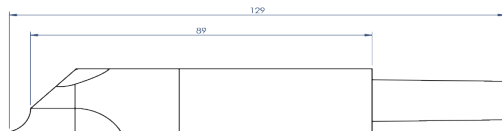
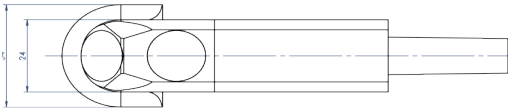

Sensor	Area velocity sensor
Sensor	1 x velocity 1 x water level 1x temperature
Frequency	1 MHz
Range	Velocity: ± 5.0 m/s Water level: 0.04 -1.3 m, expandable with external 4-20 mA level sensor Temperature: -60 °C to +150 °C (linearized: 0°C to +60°C)
Uncertainty	Velocity: ± 0.03 m/s from -1.5 m/s to +1.5 m/s ± 2 % of reading from -5.0 to -1.5 m/s and +1.5 to +5.0 m/s Level: ± 2 mm Flow: typically ± 2 %, depending on site conditions Temperature: ± 0.5 K for 4 °C to 57 °C
Measurement cells	Up to 32
Measurement interval	1 Hz (all cells)
Cable length	10 m incl. (max. 100 m)
Particle concentration	> 50 ppm
Operating temperature	-15 °C to +50 °C (non-freezing)
Material	Stainless steel (1.4571, AISI 316 Ti), PEEK (piezo cover)
Protection class	IP68 (48 h at 50 kPa, NEMA 6P)
Approval	ATEX (option)
Dimensions	129 x 24 x 19 mm (L including cable connector x W x H)