



DL-IAM DATASHEET

INDOOR AMBIANCE MONITOR FOR LORAWAN®

FEATURES

State-of-the-art CO₂ and VOC (volatile organic compounds) sensors.

Industry standard humidity and temperature sensor.

High accuracy barometric pressure sensor.

Ambient light sensor.

Motion / presence detector.

Place and measure: no setup required.

Unattended real-time monitoring for more than a year without replacing batteries.

Compatible with LoRaWAN® networks of any provider.

Standard alkaline (AA-type) batteries.

CE compliant, Radio Equipment Directive (RED) 2014/53/EU.

APPLICATIONS

Indoor air quality monitoring in offices, class rooms, hospitals, stores or malls.

Office occupancy monitoring.

Motion / activity monitoring of people in a room.

Heating, ventilation and air conditioning (HVAC) control: for good indoor air quality and energy savings.

Process yield and economic efficiency: e.g. in greenhouses, mushroom farming, food packaging, transportation/storage, chicken hatcheries and incubators.

Personal safety: in confined spaces where combustion is present or gas leakage could occur such as garages, tunnels, public bars, restaurants or burners.



DESCRIPTION

Decentlab's indoor ambiance monitor continuously measures carbon dioxide (CO₂) concentration, volatile organic compounds (VOC), temperature, humidity, barometric pressure, ambient light and motion / presence. These data allow to quantify the air quality, temperature and illumination (ambiance) in offices, class rooms, hospitals, stores or malls. These data also indicate the presence of people and how they move in a room. This allows to efficiently control heating, ventilation, air conditioning (HVAC) and illumination corresponding to the actual situation in a specific room.

Sensor data are transmitted in real-time using LoRaWAN[®] radio technology. LoRaWAN[®] enables encrypted radio transmissions over long distances while consuming very little power. The user can obtain sensor data through Decentlab's data storage and visualization system, or through the user's own infrastructure. Visit www.decentlab.com for more information about Decentlab's data cloud service.

AUTOMATIC SENSOR CALIBRATION

Barometric pressure and temperature data are used by the CO₂ sensor to compensate for temperature and pressure variations and the elevation above sea level.

In addition, the device periodically performs an automatic calibration routine for the CO₂ sensor. The calibration routine requires no interaction by the user. The calibration period is set to 8 days by default. Every 8 days, the device evaluates all sensor data of the last 8 days and performs a recalibration. The recalibration is based on the assumption that the sensor has been exposed to fresh air (which is assumed to contain 400 ppm CO₂) for at least a few minutes during this period. If the device is operated indoors, it is enough to ventilate the room with fresh air once in a while.

The user can configure the calibration period for example by the following user interface commands:

- `set param 2 192` (set calibration period to 192 hours = 8 days: recommended default)
- `set param 2 0` (disable calibration function)

Please refer to section "Device configuration" for a description of the user interfaces.

DEVICE SPECIFICATIONS

DEVICE LOGGING FUNCTION

Sampling interval	30 s (exception: CO ₂ sensor 120 s)
Data upload interval	10 min
Reported sensor data (average of samples)	Battery voltage Air temperature Air humidity Barometric pressure Ambient light (visible + infrared, infrared only) CO ₂ concentration, sensor status, raw reading Motion sensor: activity counter Total VOC concentration

CO₂ SENSOR

Operating principle	Non-dispersive infrared (NDIR)
Measurement range	0 ... 10000 ppm
Accuracy	±50 ppm or ±3 % of reading ⁶
RMS noise	25 ppm @ 1000 ppm

TEMPERATURE SENSOR

Operating principle	Digital CMOSens [®] technology
Measurement range	-40 ... 125 °C
Accuracy (typical)	±0.2 °C

HUMIDITY SENSOR

Operating principle	Digital CMOSens [®] technology
Measurement range	0 ... 100 % RH
Accuracy (typical)	±2 % RH

BAROMETRIC PRESSURE SENSOR

Operating principle	Piezo-resistive absolute pressure sensor
Operation range	300 ... 1100 hPa, -40 ... 85 °C
Accuracy (typical)	±1 hPa

1 Condition: 10 ... 40 °C, 20 ... 60 % RH; calibrated from 0 to 2000 ppm; above 2000 ppm: ±10 % accuracy (extrapolated from calibrated range)

AMBIENT LIGHT SENSOR

Operating principle	2 channel light-to-digital converter (visible + IR, IR)
Measurement range	100000 lx
Accuracy (typical)	±30 % (depending on light source, incident angle)

MOTION SENSOR

Operating principle	Passive infrared (PIR) sensor, activity counter
Detection area	94 ° horizontal, 82 ° vertical
Detection distance	5 m
Output range	0 ... 65535

VOC SENSOR

Operating principle	Heated film of metal-oxide nanoparticles (MOXSens®)
Measurement range	0 ... 60000 ppb (total VOC)
Accuracy	±15 % of reading
Long-term stability (typical)	1.3 % accuracy drift per year
Calibration	Automatic baseline compensation, humidity compensation

RADIO / WIRELESS

Wireless technology	LoRaWAN®
Wireless security	AES-128 data encryption
LoRaWAN® device type	Class A end-device
Supported LoRaWAN® features	OTAA, ABP, ADR, adaptive channel setup
Wireless range	> 10 km (line of sight ²), approx. 2 km (suburban)
RF transmit power	14 dBm (25 mW)
Effective radiated power	13.9 dBm maximum ³
Receiver sensitivity	-146 dBm ⁴
Frequency bands	868 MHz (EU version), 915 MHz (US, AS, AU versions) ⁵
Antenna	Integrated omnidirectional antenna ³

² Decentlab reports successful transmissions over 56 km distance

³ See Appendix A: Antenna performance

⁴ Specified by radio chip vendor

⁵ Contact us for region specific options

POWER SUPPLY

Internal battery type	2 × alkaline AA batteries (LR6)
Power consumption	≤ 1.0 mW
Battery lifetime ^L	1.4 years (SF7) 0.9 years (SF12)
... VOC sensor disabled	2.7 years (SF7) 1.2 years (SF12)

OPERATING CONDITIONS

Temperature	-10 ... 50 °C
Humidity	0 ... 95 % RH (non-condensing)

MECHANICAL SPECIFICATIONS

Dimensions	120 × 80 × 27 mm
Weight	144 g including batteries (98 g without batteries)
Enclosure	Self-extinguishing ABS wall-mount enclosure, white

L Including alkaline battery self-discharge of 3.6 % per year (conservative estimation); battery capacity: 7500 mWh.

OPERATING INSTRUCTIONS

Tbd.

REPLACING BATTERIES

Insert 2 high-quality alkaline AA batteries (LRL) into the battery holder on top of the sensor unit. The device operates until the battery voltage drops to 2.0 V. Always replace both battery cells with two identical fresh batteries.

OPERATING MODES

The device has four operating modes:

- Reset: System (re-)start; both LEDs fade in and out.
- Active mode (ON): Periodic measurements and data transmissions; green LED flashes for each measurement.
- Sleep mode (OFF): No measurements and data transmissions (power save mode, for shelf storage). LEDs are off.
- Test mode: Measurements and data transmissions at fastest possible rates; blue LED is on.
NOTE: Use only momentarily, e.g. for testing the sensor or the wireless connection. The device will switch automatically to active mode after 20 minutes.

SWITCHING BETWEEN OPERATING MODES

The user button allows to switch between the operating modes as shown in Illustration 1 and Illustration 2. To perform a device reset, switch to sleep mode first (if necessary) by pushing and holding the button for 3 seconds until the LEDs flash three times; wait 3 seconds; then push and hold the button for 3 seconds until the LEDs fade in and out. To switch between active and test mode, push the button for 1 second (blue LED on / off). If the blue LED is off, the device is in active or sleep mode. If the blue LED is on, the device is in test mode.

HINT: To check whether the device is active or in sleep mode (on or off), push the button twice; if the blue LED goes on and off, the device is in active mode; otherwise, the device is in sleep mode.

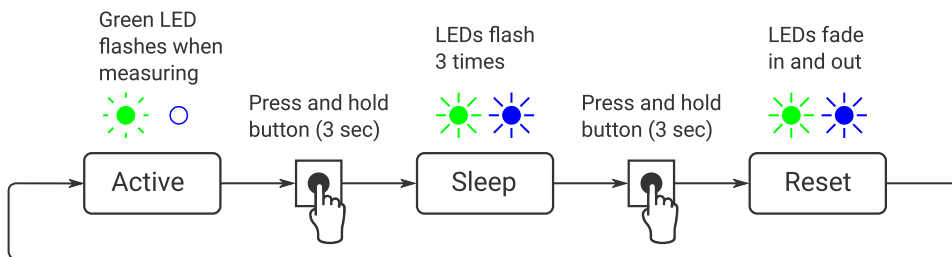

Illustration 1: Switching between active and sleep mode (switch off / on, reset).

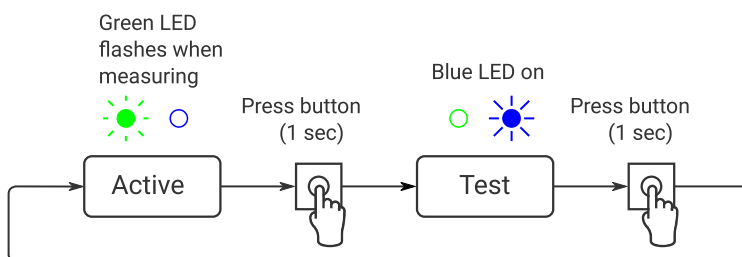

Illustration 2: Switching between active and test mode.

MEASUREMENT CYCLE (ACTIVE MODE)

During the active mode, the device periodically reads the sensors with sampling period $T_s = 30$ seconds. When the send period $T_{TX} = n \cdot T_s$ (default: $n = 20$) has expired, the device computes the average of the collected sensor values (at most 20 values). After a random delay of 0 ... 8 seconds, the device transmits the aggregated sensor data. If the device has not yet joined the LoRaWAN[®] network, it will try to join until it succeeds (maximum 3 attempts per sampling period). Afterwards, it will transmit the data (TX data). Following the data transmission, two receive slots are opened (RX1 and RX2). During these time slots, the device is ready to receive data from the network (downlink messages) as defined in the LoRaWAN[®] specification.

As shown in the diagrams, the device is idle most of the time. During the idle time, the current consumption is extremely low.

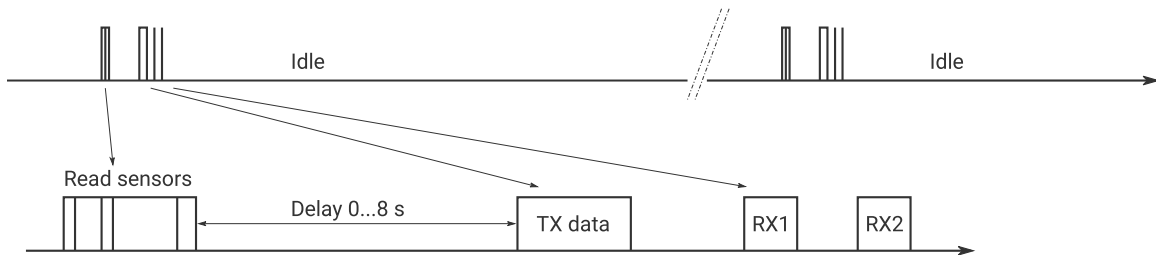

Illustration 3: Device activity during the active mode.

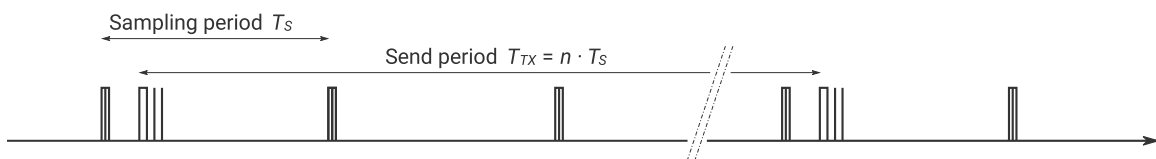

Illustration 4: Sampling period vs. send period. Default: $T_s = 30$ s, $T_{TX} = 20 \cdot 30$ s = 10 min.

LED SIGNALING (ACTIVE MODE)

- Read sensors: green LED flashes once.
- Data sent successfully: green LED flashes 2 times.
- Data could not be sent: green LED flashes 4 times.

DEVICE CONFIGURATION

The user can configure a rich set of device parameters, such as sampling interval, LoRaWAN® data rate, ADR settings and many more. If desired, the parameter settings can be stored permanently in the internal non-volatile memory. The user can configure the device via two interfaces:

- Command line interface: via a serial cable (UART – USB) connected to a computer.
- Downlink command interface: over the air using LoRaWAN® downlink messages.

For a full description of the command line interface and the downlink command interface, please find the specific documents on www.decentlab.com/support.

NOTE: For this specific device (Indoor Ambiance Monitor), the sampling interval (parameter “period”) is 30 seconds and must not be changed. Otherwise, the VOC sensor calibration is invalid and VOC data may be inaccurate. We recommend not to change “period” nor “send_period”.

MOUNTING INSTRUCTIONS

Tbd.

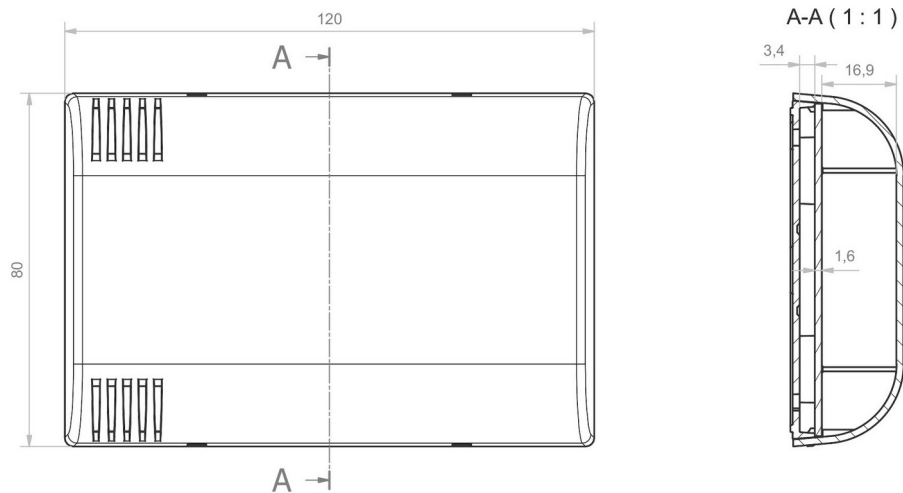

Illustration 5: Housing dimensions in mm.

ORDERING INFORMATION

REFERENCE	VERSION	REGION (LORAWAN®)
DL-IAM-001-EU868	001	Europe
DL-IAM-001-US915	001	North America
DL-IAM-001-AS923	001	Asia
DL-IAM-001-AU915	001	Australia, South America

Other options: contact us

SENSOR DATA MESSAGE FORMAT

Message:

Header	Sensor 0 data (optional)	Sensor 1 data (opt.)	...	Sensor 15 data (opt.)
--------	--------------------------	----------------------	-----	-----------------------

- Message length is variable, depending on which sensor data are included. Minimum length is 5 bytes (header only). Maximum length is 5 bytes + all sensor data (see below).
- Integers are big endian: MSB first byte, LSB last byte.

Header:

Version	Device ID	Flags
---------	-----------	-------

- Version: 1 byte; version = 2 for current protocol version.
- Device ID: 2 bytes; 0...65535.
- Flags: 16 bits: flag 15 | flag 14 | ... | flag 0 (LSB).
- The flags indicate, if data of the respective sensors are included in the message or not: Flag n == 1: sensor n data included; flag n == 0: not included.

DECODER SOFTWARE

For message decoder software, please go to <https://www.decentlab.com/support>, where you find code examples in JavaScript and other programming languages.

DETAILS

FIELD	PARAMETER NAME	TYPE	CONVERSION	UNIT
Header	Version	uint8		
Header	Device ID	uint16		
Header	Flags	uint16		
Sensor 0	Battery voltage	uint16	x / 1000	V
Sensor 1	Air temperature	uint16	x / 65535 · 175 – 45	°C
Sensor 1	Air humidity	uint16	x / 65535 · 100	%
Sensor 2	Barometric pressure	uint16	x · 2	Pa
Sensor 3	Ambient light CH0 (visible + infrared)	uint16	x	
Sensor 3	Ambient light CH1 (infrared)	uint16	x	
Sensor 4	CO ₂ concentration	uint16	x – 32768	ppm
Sensor 4	CO ₂ sensor status	uint16	x	
Sensor 4	Raw IR reading	uint16	x	
Sensor 5	PIR sensor: activity counter	uint16	x	
Sensor 6	Gas sensor: total VOC	uint16	x	ppb

Illuminance calculation in lux (lx): The raw data of the ambient light sensor (CH0, CH1) can be used to calculate the approximate illuminance. One lux is equal to one lumen per square meter. Please note that the calculated lux values depend on the type of light source (fluorescent lamp, LED lamp, incandescent lamp, sunlight) and on the incident angle of the light. The device is not intended to be used as a precision lux meter. Empirical formula:

$$\begin{aligned}
 I_1 &= (1.00 \cdot CH0 - 1.64 \cdot CH1) \cdot 1.5504 \\
 I_2 &= (0.59 \cdot CH0 - 0.86 \cdot CH1) \cdot 1.5504 \\
 I &= \max(I_1, I_2) \text{ [lx]},
 \end{aligned}$$

where CH0 and CH1 are the raw sensor values.

EXAMPLE 1 (ALL SENSOR DATA INCLUDED)

Message (hex):

020bbd007f0b926a515d48bc4e0262006981c7000093d4000b0111

02	Version	=	2	
0bbd	Device ID	=	3005	
007f	Flags	=	0b0000000001111111	
0b92	Battery voltage	=	2.96	V
6a51	Air temperature	=	27.68	deg
5d48	Air humidity	=	36.44	%
bc4e	Barometric pressure	=	96412	Pa
0262	Ambient light CH0	=	610	
0069	Ambient light CH1	=	105	
81c7	CO2 concentration	=	455	ppm
0000	CO2 sensor status	=	0	
93d4	Raw IR reading	=	37844	
000b	PIR activity counter	=	11	
0111	Gas sensor: total VOC	=	273	ppb
	Illuminance	=	679	lx

EXAMPLE 2 (CO₂ SENSOR DATA NOT INCLUDED)

Message (hex):

020bbd006f0b926a515d48bc4e02620069000b0111

02	Version	=	2	
0bbd	Device ID	=	3005	
006f	Flags	=	0b0000000001111111	
0b92	Battery voltage	=	2.96	V
6a51	Air temperature	=	27.68	deg
5d48	Air humidity	=	36.44	%
bc4e	Barometric pressure	=	96412	Pa
0262	Ambient light CH0	=	610	
0069	Ambient light CH1	=	105	
----	CO2 concentration	=	----	ppm
----	CO2 sensor status	=	----	
----	Raw IR reading	=	----	
000b	PIR activity counter	=	11	
0111	Gas sensor: total VOC	=	273	ppb
	Illuminance	=	679	lx

EXAMPLE 3 (ONLY BATTERY VOLTAGE)

Message (hex):

020bbd00010b92

02	Version	= 2	
0bbd	Device ID	= 3005	
0001	Flags	= 0b0000000000000001	
0b92	Battery voltage	= 2.96	V
----	Air temperature	= ----	deg
----	Air humidity	= ----	%
----	Barometric pressure	= ----	Pa
----	Ambient light CH0	= ----	
----	Ambient light CH1	= ----	
----	CO2 concentration	= ----	ppm
----	CO2 sensor status	= ----	
----	Raw IR reading	= ----	
----	PIR activity counter	= ----	
----	Gas sensor: total VOC	= ----	ppb
	Illuminance	= ----	lx

DECLARATION OF CONFORMITY

We,

Decentlab GmbH
Kriesbachstrasse 30
8600 Dübendorf
Switzerland



declare under our own responsibility that the product

Reference	Name
DL-IAM-xxx-EU868	Indoor Ambiance Monitor for LoRaWAN®

to which this declaration refers conforms with the relevant standards or other standards documents

- EN 300 220-1 V3.1.1: 2017-02
- EN 300 220-2 V3.1.1: 2017-02
- EN 301 489-1 V2.2.0: 2017-03
- EN 301 489-3 V2.1.1: 2017-03

According to

- Radio Equipment Directive (RED) 2014/53/EU
- Electromagnetic Compatibility (EMC) Directive 2014/30/EU

Dübendorf, 1. January 2019

Reinhard Bischoff, Managing Director

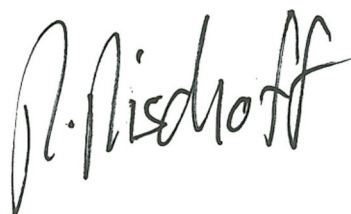

APPENDIX A: ANTENNA PERFORMANCE

No: DE.19.010.F02

Page 21 / 24

Measurement Results:

EUT	DL-IAM-868		Verdict:	Pass
Measured Power	Maximum e.r.p. = 13.90 dBm			
Test performed	Effective radiated power (ERP)			
Test setup	Radiated measurement (internal antenna)			
Mode of operation	Transmitter mode, unmodulated carrier			
Test date, time	27.02.2019 09:55:58			
Antenna height	1.30 m	Antenna polarization	Horizontal	
EUT position	0 to 360 Degree	Antenna distance	3 m	
Measurement settings	Radimation Version: 2018.2.6, RBW: 1 kHz, VBW: 300 kHz, Sweep time: Auto [120 ms], Step freq: Linear: 250 Hz steps, Attenuator: Auto [10 dB], Internal preamp: 20 dB, Measure time: 20 ms, Measurement equipment: TP_RE_30M-1G_ETSI_Hor			

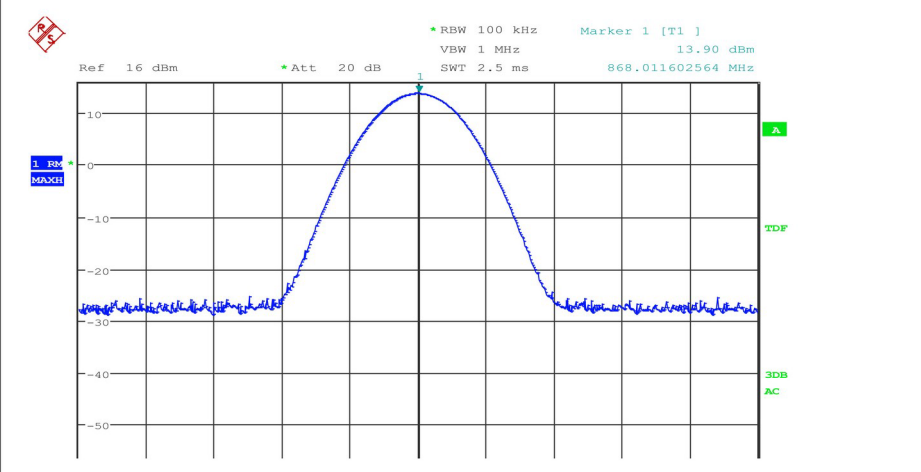
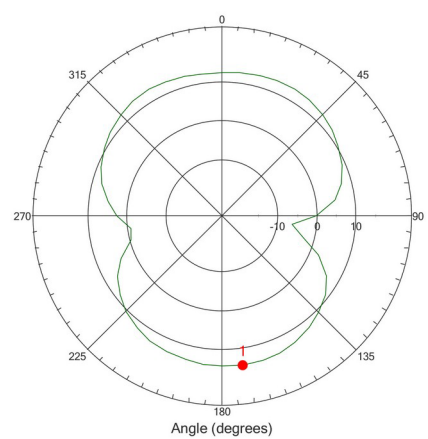
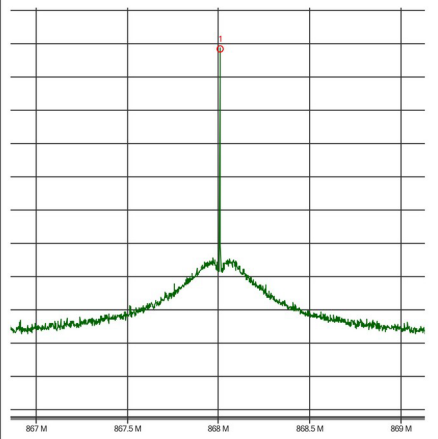

EMV Prüfstelle Zürich – Technopark – 8005 Zurich

DISCLAIMER

Specifications and information in this document are subject to change without notice.

Decentlab products are not warranted or authorized for use as critical components in medical, life-saving, or life-sustaining applications, or other applications where a failure would reasonably be expected to cause severe personal injury or death.

CONTACT INFORMATION

www.decentlab.com/contact

mail@decentlab.com

+41 44 809 35 90

Decentlab GmbH
Kriesbachstrasse 30
8600 Dübendorf
Switzerland