



## DL-LP8P DATASHEET

CO<sub>2</sub>, TEMPERATURE, HUMIDITY AND BAROMETRIC PRESSURE  
SENSOR FOR LORAWAN<sup>®</sup>

## FEATURES

State-of-the-art non-dispersive infrared (NDIR) technology to measure CO<sub>2</sub>.

Industry standard humidity and temperature sensor.

High accuracy barometric pressure sensor.

Place and measure: no setup required.

Unattended real-time monitoring for several years without replacing batteries.

Compatible with LoRaWAN® networks of any provider.

Robust polycarbonate enclosure: weatherproof, impact-, UV-resistant.

Standard alkaline (C-type) batteries.

CE compliant, Radio Equipment Directive (RED) 2014/53/EU.

## APPLICATIONS

General indoor and outdoor air quality monitoring.

Global environmental surveillance: ground and atmospheric CO<sub>2</sub> sensing.

Indoor air quality monitoring in offices, class rooms, hospitals, stores or malls.

Heating, ventilation and air conditioning (HVAC) control: for good indoor air quality and energy savings.

Process yield and economic efficiency: e.g. in greenhouses, mushroom farming, food packaging, transportation/storage, chicken hatcheries and incubators.

Personal safety: in confined spaces where combustion is present or gas leakage could occur such as garages, tunnels, public bars, restaurants or burners.



## DESCRIPTION

Decentlab's outdoor-ready air quality monitor continuously measures carbon dioxide (CO<sub>2</sub>) concentration, temperature, humidity and barometric pressure.

Sensor data are transmitted in real-time using LoRaWAN<sup>®</sup> radio technology. LoRaWAN<sup>®</sup> enables encrypted radio transmissions over long distances while consuming very little power. The user can obtain sensor data through Decentlab's data storage and visualization system, or through the user's own infrastructure. Visit [www.decentlab.com](http://www.decentlab.com) for more information about Decentlab's data cloud service.

## AUTOMATIC SENSOR CALIBRATION

Barometric pressure and temperature data are used by the CO<sub>2</sub> sensor to compensate for temperature and pressure variations and the elevation above sea level.

In addition, the device periodically performs an automatic calibration routine for the CO<sub>2</sub> sensor. The calibration routine requires no interaction by the user. The calibration period is set to 8 days by default. Every 8 days, the device evaluates all sensor data of the last 8 days and performs a recalibration. The recalibration is based on the assumption that the sensor has been exposed to fresh air (which is assumed to contain 400 ppm CO<sub>2</sub>) for at least a few minutes during this period. If the device is operated indoors, it is enough to ventilate the room with fresh air once in a while.

The user can configure the calibration period for example by the following user interface commands:

- `set param 2 192` (set calibration period to 192 hours = 8 days: recommended default)
- `set param 2 0` (disable calibration function)

Please refer to section "Device configuration" for a description of the user interfaces.

## DEVICE SPECIFICATIONS

### DEVICE LOGGING FUNCTION

|  |   |
|--|---|
| Sampling interval                            | 1 min (configurable through the user interface)   |
| Data upload interval                         | 10 min (configurable through the user interface)  |
| Reported sensor data<br>(average of samples) | CO <sub>2</sub> concentration (filtered / unfiltered)<br>CO <sub>2</sub> sensor raw values (filtered / unfiltered)<br>CO <sub>2</sub> sensor temperature<br>CO <sub>2</sub> sensor status information<br>Air humidity and temperature<br>Barometric pressure and temperature<br>Battery voltage |

### CO<sub>2</sub> SENSOR

|                     |   |
|---------------------|---|
| Operating principle | Non-dispersive infrared (NDIR)          |
| Measurement range   | 0 ... 10000 ppm                         |
| Accuracy            | ±50 ppm or ±3 % of reading <sup>7</sup> |
| RMS noise           | 25 ppm @ 1000 ppm                       |

### TEMPERATURE SENSOR

|                     |   |
|---------------------|---|
| Operating principle | Digital CMOSens <sup>®</sup> technology |
| Measurement range   | -40 ... 125 °C                          |
| Accuracy (typical)  | ±0.3 °C                                 |

### HUMIDITY SENSOR

|                     |   |
|---------------------|---|
| Operating principle | Digital CMOSens <sup>®</sup> technology |
| Measurement range   | 0 ... 100 % RH                          |
| Accuracy (typical)  | ±2 % RH                                 |

### BAROMETRIC PRESSURE SENSOR

|                     |  |
|---------------------|--|
| Operating principle | Piezo-resistive absolute pressure sensor |
| Operation range     | 300 ... 1100 hPa, -40 ... 85 °C          |
| Accuracy (typical)  | ±1 hPa                                   |

1 Condition: 10 ... 40 °C, 20 ... 60 % RH; calibrated from 0 to 2000 ppm; above 2000 ppm: ±10 % accuracy (extrapolated from calibrated range)

## RADIO / WIRELESS

|                             |  |
|-----------------------------|--|
| Wireless technology         | LoRaWAN®   |
| Wireless security           | AES-128 data encryption  |
| LoRaWAN® device type        | Class A end-device   |
| Supported LoRaWAN® features | OTAA, ABP, ADR, adaptive channel setup   |
| Wireless range              | > 10 km (line of sight <sup>2</sup> ), approx. 2 km (suburban)                             |
| RF transmit power           | 14 dBm (25 mW)   |
| Effective radiated power    | 11.9 dBm <sup>3</sup>  |
| Receiver sensitivity        | -146 dBm (specified by radio chip vendor)  |
| Frequency bands             | 868 MHz (EU version), 915 MHz (US, AS, AU versions) <sup>8</sup>                           |
| Antenna                     | Integrated omnidirectional antenna featuring a near-perfect radiation pattern <sup>4</sup> |

## POWER SUPPLY

|                                 |                                 |             |      |            |
|---------------------------------|---------------------------------|-------------|------|------------|
| Internal battery type           | 2 × alkaline C batteries (LR14) |             |      |            |
| Power consumption               | ≤ 0.9 mW                        |             |      |            |
| Battery lifetime <sup>5</sup> : | Sampling period                 | Send period | SF   | Lifetime   |
|                                 | 1 min                           | 10 min      | SF7  | 5.1 years  |
|                                 | 1 min                           | 10 min      | SF12 | 2.4 years  |
|                                 | 10 min                          | 10 min      | SF7  | 9.9 years  |
|                                 | 10 min                          | 10 min      | SF12 | 2.9 years  |
|                                 | 6 min                           | 60 min      | SF7  | 12.5 years |
|                                 | 6 min                           | 60 min      | SF12 | 8.7 years  |

## OPERATING CONDITIONS

|             |                                |
|-------------|--------------------------------|
| Temperature | -10 ... 50 °C                  |
| Humidity    | 0 ... 95 % RH (non-condensing) |

## MECHANICAL SPECIFICATIONS

|            |  |
|------------|--|
| Dimensions | 122 × 81 × 67 mm   |
| Weight     | 376 g including batteries (246 g without batteries)  |
| Enclosure  | Polycarbonate (weatherproof, impact-, UV-resistant).<br>Air inlet on the bottom: protected by shroud and a fine-meshed stainless grid. |

2 Decentlab reports successful transmissions over 56 km distance

3 See Appendix A: Antenna performance

4 Contact us for region specific options

5 Including alkaline battery self-discharge of 3.6 % per year (conservative estimation); battery capacity: 20000 mWh.

## OPERATING INSTRUCTIONS

The product usually requires no user interaction. If you open the enclosure, e.g. in order to replace the batteries, unscrew the four plastic screws and carefully open the lid.

**CAUTION:** Make sure the sensor unit does not drop out of the enclosure while opening! Do not touch the electronic components and sensors! Particularly the CO<sub>2</sub> sensor is very sensitive to mechanical stress.

**NOTE:** When closing the lid, make sure the lid is fitted the right way, so that the enclosure is properly sealed: A little nose in the enclosure fits a notch in the lid and vice versa.

## REPLACING BATTERIES

Insert 2 high-quality alkaline C batteries (LR14) into the battery holder on top of the sensor unit. The device operates until the battery voltage drops to 2.0 V. Always replace both battery cells with two identical fresh batteries.

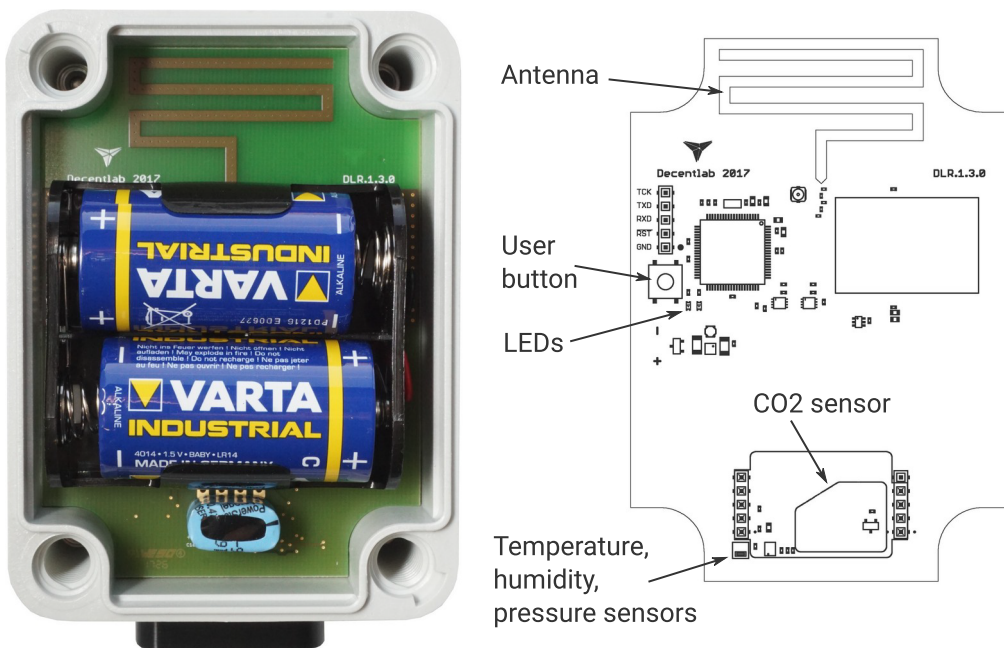

Illustration 1: Sensor unit inside enclosure with batteries inserted (left); component side of the sensor unit (right).

## OPERATING MODES

The device has four operating modes:

- Reset: System (re-)start; both LEDs fade in and out.
- Active mode (ON): Periodic measurements and data transmissions; green LED flashes for each measurement.
- Sleep mode (OFF): No measurements and data transmissions (power save mode, for shelf storage). LEDs are off.
- Test mode: Measurements and data transmissions at fastest possible rates; blue LED is on.  
NOTE: Use only momentarily, e.g. for testing the sensor or the wireless connection. The device will switch automatically to active mode after 20 minutes.

### SWITCHING BETWEEN OPERATING MODES

The user button allows to switch between the operating modes as shown in Illustration 2 and Illustration 3. To perform a device reset, switch to sleep mode first (if necessary) by pushing and holding the button for 3 seconds until the LEDs flash three times; wait 3 seconds; then push and hold the button for 3 seconds until the LEDs fade in and out. To switch between active and test mode, push the button for 1 second (blue LED on / off). If the blue LED is off, the device is in active or sleep mode. If the blue LED is on, the device is in test mode.

HINT: To check whether the device is active or in sleep mode (on or off), push the button twice; if the blue LED goes on and off, the device is in active mode; otherwise, the device is in sleep mode.

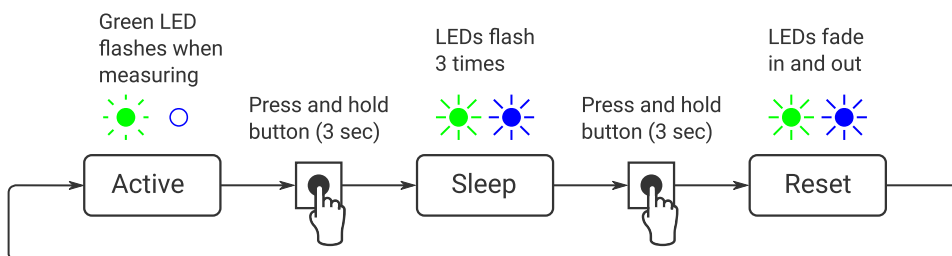

Illustration 2: Switching between active and sleep mode (switch off / on, reset).

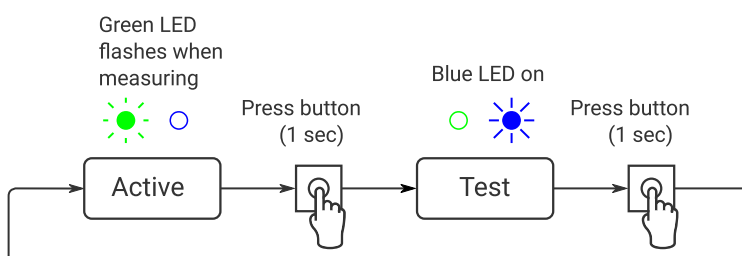

Illustration 3: Switching between active and test mode.

## MEASUREMENT CYCLE (ACTIVE MODE)

During the active mode, the device periodically reads the sensors with sampling period  $T_s$  (default: 1 min). When the send period  $T_{TX} = n \cdot T_s$  (default:  $n = 10$ ) has expired, the device computes the average of the collected sensor values (at most 10 values). After a random delay of 0 ... 8 seconds, the device transmits the aggregated sensor data. If the device has not yet joined the LoRaWAN® network, it will try to join until it succeeds (maximum 3 attempts per sampling period). Afterwards, it will transmit the data (TX data). Following the data transmission, two receive slots are opened (RX1 and RX2). During these time slots, the device is ready to receive data from the network (downlink messages) as defined in the LoRaWAN® specification.

As shown in the diagrams, the device is idle most of the time. During the idle time, the current consumption is extremely low.

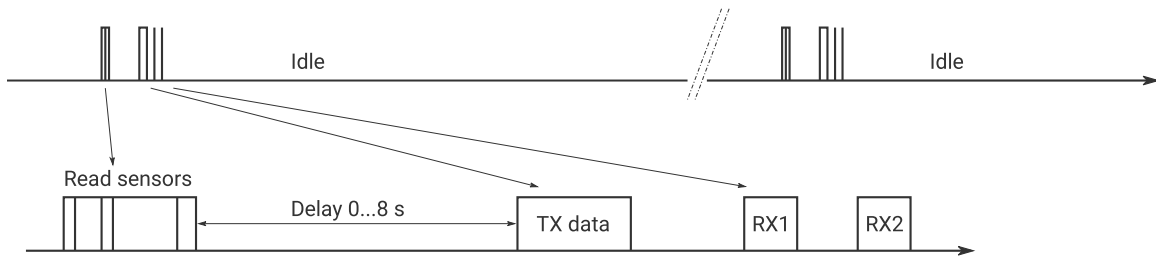

Illustration 4: Device activity during the active mode.

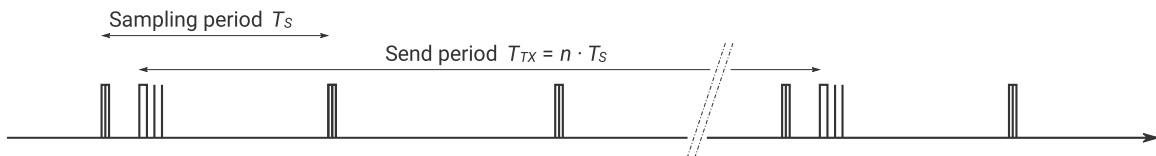

Illustration 5: Sampling period vs. send period. Default:  $T_s = 1 \text{ min}$ ,  $T_{TX} = 10 \cdot 1 \text{ min} = 10 \text{ min}$ .

## LED SIGNALING (ACTIVE MODE)

- Read sensors: green LED flashes once.
- Data sent successfully: green LED flashes 2 times.
- Data could not be sent: green LED flashes 4 times.



## DEVICE CONFIGURATION

The user can configure a rich set of device parameters, such as sampling interval, LoRaWAN® data rate, ADR settings and many more. If desired, the parameter settings can be stored permanently in the internal non-volatile memory. The user can configure the device via two interfaces:

- Command line interface: via a serial cable (UART – USB) connected to a computer.
- Downlink command interface: over the air using LoRaWAN® downlink messages.

For a full description of the command line interface and the downlink command interface, please find the specific documents on [www.decentlab.com/support](http://www.decentlab.com/support).

# MOUNTING INSTRUCTIONS

Mount the device in upright position, the air inlet facing downward. Prefer a mounting location which is protected against rain and direct sun radiation in order to achieve best sensor data quality.

For best radio performance, install the device upright with the opening towards ground; ideally, in such a way that the device lid faces roughly in the direction of the next gateway. Also, the higher above ground, the better. Avoid metallic objects close to the device.

The housing includes 4 threaded bushes (M4) in a 90 × 60 mm rectangle (see Illustration 6). This enables easy installation using standard M4 bolts.

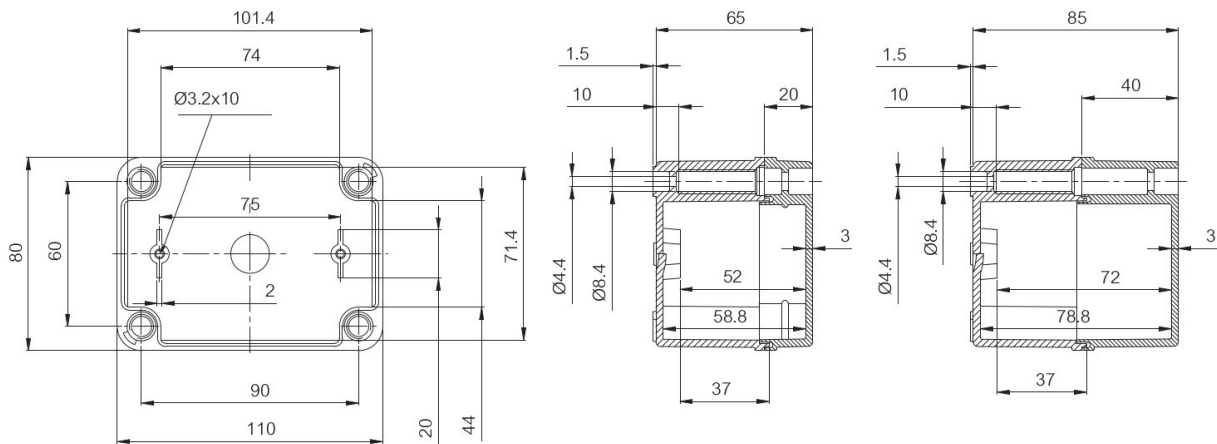

Illustration K: Housing dimensions (in mm). Note: Drawing not including air inlet.

## ORDERING INFORMATION

---

| REFERENCE         | VERSION | REGION (LORAWAN®)        |
|-------------------|---------|--------------------------|
| DL-LP8P-001-EU868 | 001     | Europe                   |
| DL-LP8P-001-US915 | 001     | North America            |
| DL-LP8P-001-AS923 | 001     | Asia                     |
| DL-LP8P-001-AU915 | 001     | Australia, South America |

Other options: contact us

---

## SENSOR DATA MESSAGE FORMAT

Message:

|        |                          |                      |     |                       |
|--------|--------------------------|----------------------|-----|-----------------------|
| Header | Sensor 0 data (optional) | Sensor 1 data (opt.) | ... | Sensor 15 data (opt.) |
|--------|--------------------------|----------------------|-----|-----------------------|

- Message length is variable, depending on which sensor data are included. Minimum length is 5 bytes (header only). Maximum length is 5 bytes + all sensor data (see below).
- Integers are big endian: MSB first byte, LSB last byte.

Header:

|         |           |       |
|---------|-----------|-------|
| Version | Device ID | Flags |
|---------|-----------|-------|

- Version: 1 byte; version = 2 for current protocol version.
- Device ID: 2 bytes; 0...65535.
- Flags: 16 bits: flag 15 | flag 14 | ... | flag 0 (LSB).
- The flags indicate, if data of the respective sensors are included in the message or not: Flag n == 1: sensor n data included; flag n == 0: not included.

## DECODER SOFTWARE

For message decoder software, please go to <https://www.decentlab.com/support>, where you find code examples in JavaScript and other programming languages.

## DETAILS

| FIELD    | PARAMETER NAME                                    | TYPE   | CONVERSION                       | UNIT |
|----------|---|--------|----------------------------------|------|
| Header   | Version   | uint8  |                                  |      |
| Header   | Device ID   | uint16 |                                  |      |
| Header   | Flags   | uint16 |                                  |      |
| Sensor 0 | Air temperature                                   | uint16 | $x / 65536 \cdot 175.72 - 46.85$ | °C   |
| Sensor 0 | Air humidity                                      | uint16 | $x / 65536 \cdot 125 - 6$        | %    |
| Sensor 1 | Barometer temperature                             | uint16 | $(x - 5000) / 100$               | °C   |
| Sensor 1 | Barometric pressure                               | uint16 | $x \cdot 2$                      | Pa   |
| Sensor 2 | CO <sub>2</sub> concentration                     | uint16 | $x - 32768$                      | ppm  |
| Sensor 2 | CO <sub>2</sub> concentration (low-pass filtered) | uint16 | $x - 32768$                      | ppm  |
| Sensor 2 | CO <sub>2</sub> sensor temperature                | uint16 | $(x - 32768) / 100$              | °C   |
| Sensor 2 | Capacitor voltage 1                               | uint16 | $x / 1000$                       | V    |
| Sensor 2 | Capacitor voltage 2                               | uint16 | $x / 1000$                       | V    |
| Sensor 2 | CO <sub>2</sub> sensor status                     | uint16 | x                                |      |
| Sensor 2 | Raw IR reading                                    | uint16 | x                                |      |
| Sensor 2 | Raw IR reading (low-pass filtered)                | uint16 | x                                |      |
| Sensor 3 | Battery voltage                                   | uint16 | $x / 1000$                       | V    |

### EXAMPLE 1 (ALL SENSOR DATA INCLUDED)

Message (hex):

**020578000f67bd618d1cedbd1081d981f4895b0bd80bb50000959895390c25**

|             |                         |   |                    |     |
|-------------|-------------------------|---|--------------------|-----|
| <b>02</b>   | Version                 | = | 2                  |     |
| <b>0578</b> | Device ID               | = | 1400               |     |
| <b>000f</b> | Flags                   | = | 0b0000000000001111 |     |
| <b>67bd</b> | Air temperature         | = | 24.36              | deg |
| <b>618d</b> | Air humidity            | = | 41.63              | %   |
| <b>1ced</b> | Barometer temperature   | = | 24.05              | deg |
| <b>bd10</b> | Barometric pressure     | = | 96800              | Pa  |
| <b>81d9</b> | CO2 concentration       | = | 473                | ppm |
| <b>81f4</b> | CO2 concentration (LPF) | = | 500                | ppm |
| <b>895b</b> | CO2 sensor temperature  | = | 23.95              | deg |
| <b>0bd8</b> | Capacitor voltage 1     | = | 3.032              | V   |
| <b>0bb5</b> | Capacitor voltage 2     | = | 2.997              | V   |
| <b>0000</b> | CO2 sensor status       | = | 0                  |     |
| <b>9598</b> | Raw IR reading          | = | 38296              |     |
| <b>9539</b> | Raw IR reading (LPF)    | = | 38201              |     |
| <b>0c25</b> | Battery voltage         | = | 3.109              | V   |

EXAMPLE 2 (CO<sub>2</sub> SENSOR DATA NOT INCLUDED)

Message (hex):

**020578000b67bd618d1cedbd100c25**

|             |                         |   |                    |     |
|-------------|-------------------------|---|--------------------|-----|
| <b>02</b>   | Version                 | = | 2                  |     |
| <b>0578</b> | Device ID               | = | 1400               |     |
| <b>000b</b> | Flags                   | = | 0b0000000000001111 |     |
| <b>67bd</b> | Air temperature         | = | 24.36              | deg |
| <b>618d</b> | Air humidity            | = | 41.63              | %   |
| <b>1ced</b> | Barometer temperature   | = | 24.05              | deg |
| <b>bd10</b> | Barometric pressure     | = | 96800              | Pa  |
| ----        | CO2 concentration       | = | ----               | ppm |
| ----        | CO2 concentration (LPF) | = | ----               | ppm |
| ----        | CO2 sensor temperature  | = | ----               | deg |
| ----        | Capacitor voltage 1     | = | ----               | V   |
| ----        | Capacitor voltage 2     | = | ----               | V   |
| ----        | CO2 sensor status       | = | ----               |     |
| ----        | Raw IR reading          | = | ----               |     |
| ----        | Raw IR reading (LPF)    | = | ----               |     |
| <b>0c25</b> | Battery voltage         | = | 3.109              | V   |

### EXAMPLE 3 (ONLY BATTERY VOLTAGE)

Message (hex):

**02057800080c25**

|             |                         |   |                    |     |
|-------------|-------------------------|---|--------------------|-----|
| <b>02</b>   | Version                 | = | 2                  |     |
| <b>0578</b> | Device ID               | = | 1400               |     |
| <b>0008</b> | Flags                   | = | 0b0000000000001000 |     |
| ----        | Air temperature         | = | ----               | deg |
| ----        | Air humidity            | = | ----               | %   |
| ----        | Barometer temperature   | = | ----               | deg |
| ----        | Barometric pressure     | = | ----               | Pa  |
| ----        | CO2 concentration       | = | ----               | ppm |
| ----        | CO2 concentration (LPF) | = | ----               | ppm |
| ----        | CO2 sensor temperature  | = | ----               | deg |
| ----        | Capacitor voltage 1     | = | ----               | V   |
| ----        | Capacitor voltage 2     | = | ----               | V   |
| ----        | CO2 sensor status       | = | ----               |     |
| ----        | Raw IR reading          | = | ----               |     |
| ----        | Raw IR reading (LPF)    | = | ----               |     |
| <b>0c25</b> | Battery voltage         | = | 3.109              | V   |



## DECLARATION OF CONFORMITY

We,

Decentlab GmbH  
Kriesbachstrasse 30  
8600 Dübendorf  
Switzerland



declare under our own responsibility that the product

| Reference                | Name  |
|--------------------------|---|
| <b>DL-LP8P-xxx-EU868</b> | <b>CO<sub>2</sub>, Temperature, Humidity and Barometric Pressure Sensor for LoRaWAN</b> |

to which this declaration refers conforms with the relevant standards or other standards documents

- EN 300 220-1 V3.1.1: 2017-02
- EN 300 220-2 V3.1.1: 2017-02
- EN 301 489-1 V2.2.0: 2017-03
- EN 301 489-3 V2.1.1: 2017-03

According to

- Radio Equipment Directive (RED) 2014/53/EU
- Electromagnetic Compatibility (EMC) Directive 2014/30/EU

Dübendorf, 27. July 2018

Reinhard Bischoff, Managing Director



# APPENDIX A: ANTENNA PERFORMANCE

No : **DE.17.039.F01**

Page 21 / 24

**Measurement Results:**

|                             |   |                             |          |
|-----------------------------|---|-----------------------------|----------|
| <b>EUT</b>                  | DLR1-LP8  |                             |          |
| <b>Test performed</b>       | Effective radiated power (ERP)  |                             |          |
| <b>Verdict, Test</b>        | Pass  |                             |          |
| <b>Modification</b>         | None  |                             |          |
| <b>Mode of operation</b>    | Transmitter mode  |                             |          |
| <b>Test date, time</b>      | 13.06.2018 09:37:06   |                             |          |
| <b>Antenna height</b>       | 1.30 m  | <b>Antenna polarization</b> | Vertical |
| <b>EUT position</b>         | 0 to 360 Degree   | <b>Antenna distance</b>     | 3 m      |
| <b>Measurement settings</b> | Radimation Version: 2017.1.6, RBW: 1 kHz, VBW: 300 kHz, Sweep time: Auto [120 ms], Step freq: Linear: 250 Hz steps, Attenuator: Auto [10 dB], Internal preamp: 20 dB, Measure time: 10 ms, Measurement equipment: TP_RE_30M-1G_ETSI_Ver |                             |          |

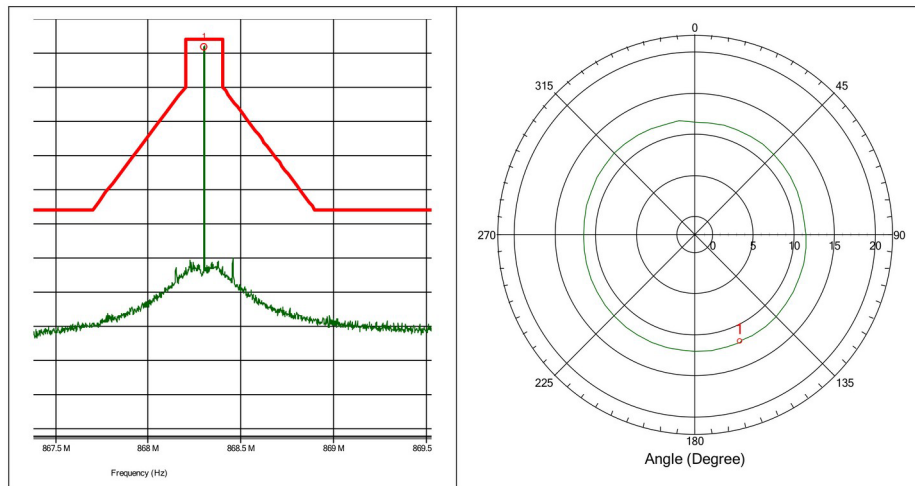

**Detected peaks**

| Peak Number | Frequency   | Peak     | Peak Difference | Status | Angle      | Height | Polarization |
|-------------|-------------|----------|-----------------|--------|------------|--------|--------------|
| 1           | 868.302 MHz | 11.9 dBm | -2.14 dB        | Pass   | 157 Degree | 1.3 m  | Vertical     |

**Limits:**

|   |                                    |
|---|------------------------------------|
| ETSI EN 300 220-2, Table C.1<br>OFB: 863 MHz to 870 MHz<br><= 0.1% duty cycle or polite spectrum access | <b>25 mW e.r.p</b><br><br>(14 dBm) |
|---|------------------------------------|

## DISCLAIMER

Specifications and information in this document are subject to change without notice.

Decentlab products are not warranted or authorized for use as critical components in medical, life-saving, or life-sustaining applications, or other applications where a failure would reasonably be expected to cause severe personal injury or death.

## CONTACT INFORMATION

[www.decentlab.com/contact](http://www.decentlab.com/contact)

[mail@decentlab.com](mailto:mail@decentlab.com)

+41 44 809 35 90

Decentlab GmbH  
Kriesbachstrasse 30  
8600 Dübendorf  
Switzerland